KODAK EASYSHARE SPORT Camera / C135



Extended user guide

www.kodak.com

For interactive tutorials:

www.kodak.com/go/c135demos

For help with your camera:

www.kodak.com/go/c135support

Kodak

Eastman Kodak Company
Rochester, New York 14650
© Eastman Kodak Company, 2012

All screen images are simulated.

Kodak, EasyShare Sport, Max, Perfect Touch, and Pulse are trademarks of Eastman Kodak Company.

4H8874_en

Front view

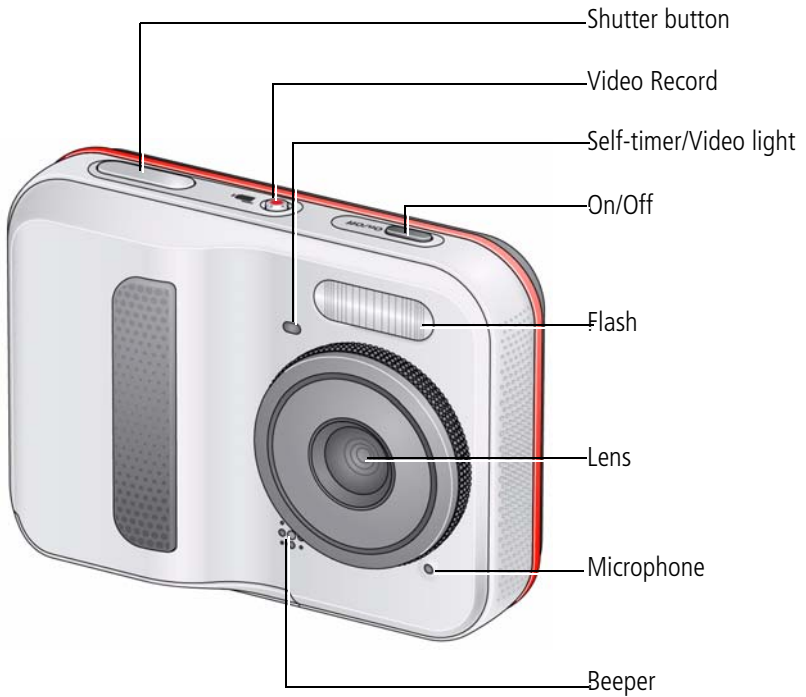

Back view

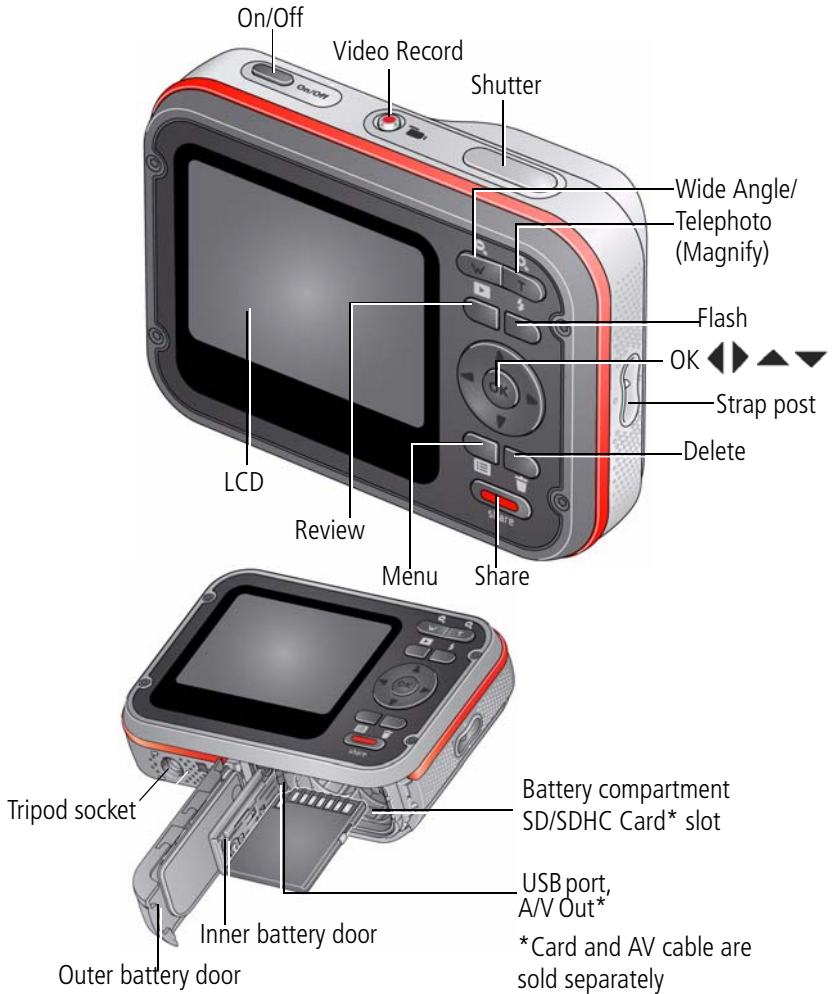

Table of contents

1	Setting up your camera	1
	Attaching the wrist strap	1
	Opening the doors	2
	Loading the AA batteries	3
	Inserting an SD or SDHC Card (not included)	4
	Closing the doors	5
	Turning on the camera	6
	Setting the language and date/time	6
2	Installing, setting up software	7
	Start sharing—in 2 easy steps	7
	Installing the KODAK Share Button App	7
	Setting up the Share Button App (one-time setup)	8
	After setting up the Share Button App	9
3	Taking pictures/videos	10
	Taking pictures	10
	Taking a video	10
	Understanding the picture-taking icons	12
	Know when your batteries need attention	12
	Using the digital zoom	13
	Using the flash	13
	Using different modes	14
	Using shortcuts	16
	Using the self-timer and burst	17
	Using the camera under water	18
4	Sharing pictures/videos	19
	Sharing through social networks	19
	Tagging pictures/videos with keywords	20
	Marking pictures/videos for emailing	21

5	Reviewing and editing	22
	Reviewing pictures/videos	22
	Deleting pictures/videos	23
	Viewing pictures/videos in different ways.....	24
	A smarter way to find and enjoy your pictures.....	25
	Understanding the review icons.....	26
	Creating a slide show.....	27
	Displaying pictures/videos on a television.....	28
	Using the menu button in review.....	29
	Cropping pictures.....	29
	Editing videos	30
	Selecting multiple pictures/videos	32
	Rotating pictures.....	32
	Using KODAK PERFECT TOUCH Technology.....	33
	Adding a date stamp.....	33
6	Doing more with your camera	34
	Using the menu button to change settings in picture taking mode.....	34
	Using the Setup menu.....	36
7	Transferring, printing pictures	38
	Printing pictures	39
	Marking your pictures for print	40
8	Using an EYE-FI Card	41
	Storing pictures on an EYE-FI Card	41
	Sharing pictures using an EYE-FI Card.....	42
	Transferring pictures using an EYE-FI Card.....	43
	Other EYE-FI Information.....	44
9	Troubleshooting	45
	Camera problems.....	45
	Getting help on the Web.....	49
10	Appendix	50

Camera specifications	50
Care and maintenance	52
Upgrading your software and firmware.....	53
Storage capacities	53
Important safety instructions	53
Battery replacement, battery life	54
Limited warranty	55
Regulatory compliance	56

1

Setting up your camera

Attaching the wrist strap



Opening the doors

1



2

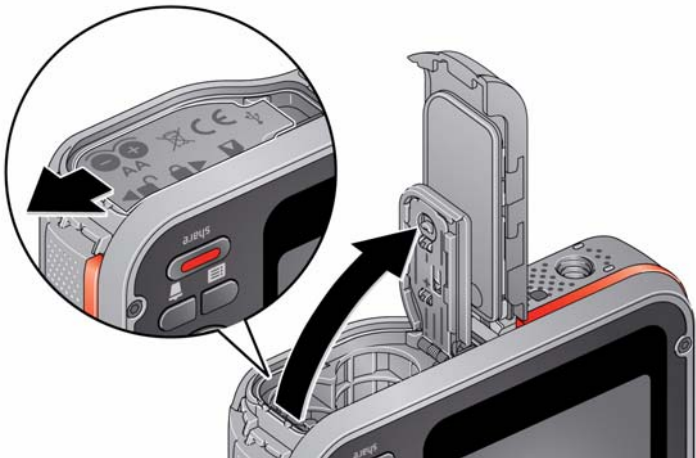

Loading the AA batteries

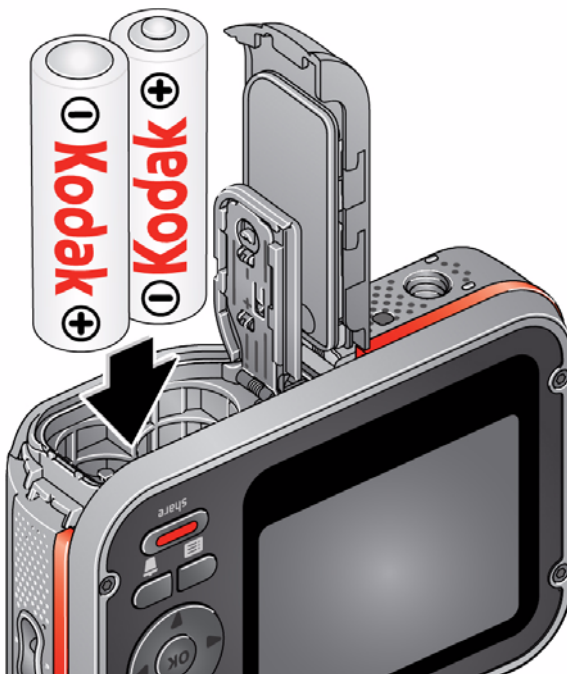

Purchase extra batteries for your event

www.kodak.com/go/accessories

IMPORTANT: Do not attempt to close both doors at the same time or leakage may occur when the camera is exposed to water.

Inserting an SD or SDHC Card (not included)

You **must** insert an SD or SDHC Card (up to 32 GB) to store pictures/videos.

NOTE: Your camera also accepts EYE-Fi Cards, X2 or higher, with a firmware version of 4.5174 or higher.
View and update firmware using the Eye-Fi Center Software that accompanies the card.



CAUTION:

A card can only be inserted one way; forcing it may cause damage. Inserting or removing a card while the camera is on may damage the pictures, the card, or the camera.

- 1 Turn off the camera.
- 2 Insert a card until it clicks.
- 3 Turn on the camera.



Purchase accessories www.kodak.com/go/accessories

Closing the doors

- 1 Close inner battery door.



- 2 Close outer battery door.



Turning on the camera

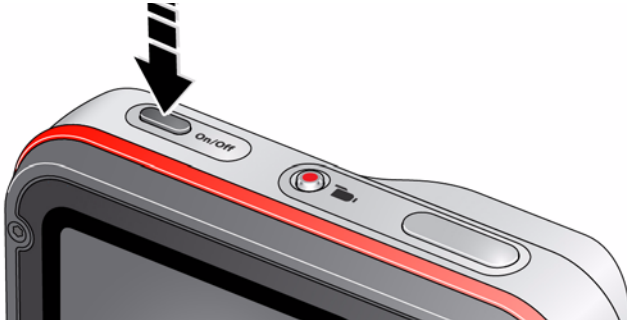

Setting the language and date/time

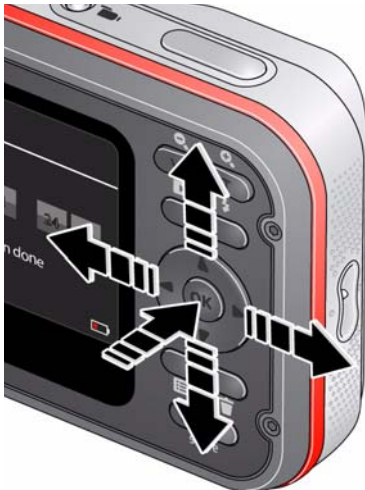

Language:
▲▼ to change.
OK to accept.

Date/Time:
At the prompt, press OK.
▲▼ to change current field.
◀▶ for previous/next field.
OK to accept.

NOTE: To change language in the future, use the Setup Menu ([see page 36](#)).

2

Installing, setting up software

Start sharing—in 2 easy steps

- 1 *One-time setup on your computer:*
 - Install the Share Button App.
 - Set up the Share Button App.
- 2 *Then, on your camera:*
 - Take pictures/videos.
 - Choose pictures/videos to share.
 - Connect camera to computer—share!

Installing the KODAK Share Button App

IMPORTANT: To enable the camera Share button for email and social network sharing, you must install and set up the KODAK Share Button App.

- 1 Verify that the computer is connected to the Internet.
- 2 Turn on the camera.



- 3 Using the KODAK Camera USB Cable, connect the camera to a computer USB port.
- 4 Watch your computer—when the KODAK Camera Setup App prompts you, click Install Now. (If your computer asks you to allow the KODAK Camera Setup App to run, click Allow.)
- 5 Click Finish.

Did you successfully install the software?

See “Setting up the Share Button App (one-time setup)” on page 8.

Did you have trouble installing the software?

See “If software installation does not start after several minutes” on page 8.

If software installation does not start after several minutes

- 1 Verify that the computer is connected to the Internet.
- 2 Open My Computer.
- 3 Open the KODAK Setup App to start the installation.

If the installer still doesn't start

- 1 Download it from www.kodak.com/go/camerasw.
- 2 After it's downloaded, double-click to install it.

Setting up the Share Button App (one-time setup)

After you install the Share Button App on your computer and click Finish (see page 7), the App automatically launches.* It prompts you through a one-time setup of your email and social networking preferences. The addresses and sites that you choose appear on your camera when you press the Share button.

If the Share Button App doesn't launch

The camera may have timed out. Simply unplug the camera and turn it off. Plug it back in and turn it on. When the App launches, perform the one-time setup, above.

A helpful hint: adding new email addresses to your camera

For future reference, the easiest way to add email addresses to *your camera* is using the Share Button App *on your computer*.

- 1 Turn on your camera.
- 2 Using the KODAK Camera USB Cable, connect the camera to a computer USB port.

The Share Button App starts.

- 3 Click Email List Setup.
- 4 Add email addresses.

The next time you connect the camera to the computer, the email addresses are added to your camera.

After setting up the Share Button App

Congratulations—you're ready to share!

- Take some pictures/videos ([see page 10](#)).
- Choose pictures/videos to share ([see page 19](#)).
- Connect the camera to your computer ([see page 7](#)).

Each time you connect:

- *Pictures/videos are transferred to your computer*
- *The Share Button App emails and/or shares your chosen pictures/videos on your social networking sites.*

3 Taking pictures/videos



Taking pictures



- 1 The camera turns on in Auto mode.
(If it's in a different mode, press ▲▼ until the LCD displays Auto )
- 2 Compose the picture.
- 3 Press the Shutter button.

Taking a video



- 1 Press the Video Record  button to start recording.
 - 2 To stop recording, press the Video Record  button again.
- To review and work with videos, see [page 22](#).

Reviewing the picture/video just taken

After you take a picture/video, the LCD briefly displays the picture or the first frame of a video.



While a picture/video appears on your camera screen, you may:

Play/pause a picture/video

Delete the current picture/video

NOTE: The camera captures audio during recording, but audio **cannot** be heard during playback on the camera. Audio **can** be heard when the video is played on a computer or when the camera is connected to a TV ([see page 28](#)).

To review pictures/videos anytime, [see page 22](#).

Understanding the picture-taking icons

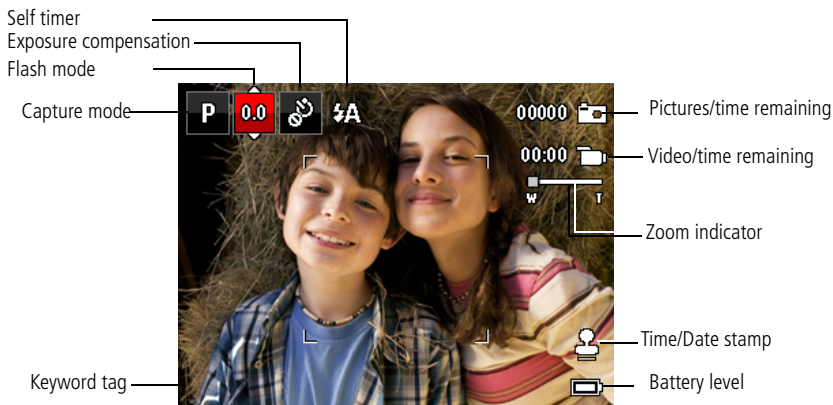

Know when your batteries need attention

The battery level icon appears when the battery requires your attention.

Full	
Three quarters	
Half	
One Quarter	
Critical	

Purchase extra batteries for your special event www.kodak.com/go/accessories

Using the digital zoom



- 1 Use the LCD to frame your subject.
- 2 To zoom in, press Telephoto (T).
To zoom out, press Wide Angle (W).

The zoom slider shows the zoom level on the LCD.

- 3 Take the picture.

NOTE: You may notice decreased image quality when using digital zoom.

Using the flash

Press the Flash button repeatedly until the LCD displays the desired flash mode.





Flash button

Flash modes		Flash fires
Auto		When the lighting conditions require it.
Fill (Flash On)		Every time you take a picture, regardless of the lighting conditions. Use when the subject is in shadow or is "backlit" (when the light is behind the subject). NOTE: Not available in Auto mode.
Red-eye Reduction	Preflash 	A preflash fires, shrinking the eye pupil, before the picture is taken.
Off		Never

Using different modes

Press ▲▼ until the LCD displays the mode that best suits your subjects and surroundings.

Use this mode	For
 Auto	General picture taking—it offers excellent image quality and ease of use. You can choose the best picture size and aspect ratio for your needs—just press the Menu  button and choose Picture Size.
SCN Scene	Point-and-shoot simplicity when taking pictures in practically any situation. (See page 15 .)
H₂O Underwater	Best for taking videos/pictures under water.

To take a video [see page 7](#).

Using Scene (SCN) modes

Choose a Scene mode—for great pictures in practically any situation.

1 Press ▲▼ until the LCD displays SCN, then press OK.

2 Press ◀▶ to view scene mode descriptions.

If the mode description turns off before you finish reading it, press OK.

3 Press OK to choose a Scene mode.

SCN mode	For
Portrait	Use for full-frame photos of people and other subjects.
Sport	Use to reduce the effect of fast action.
Sunset	Use in sunset light.
Backlight	Use for photos where light is behind subject.
Children	Use for action photos of children in bright light.
Bright	Use for bright, outdoor pictures including snow or beach scenes.
Fireworks	Use for photos of fireworks. Steady camera for best results.
Night Portrait	Use at night to capture both subject and background.

Using shortcuts

For quick access to the most popular capture and review functions:

- 1 Press ◀▶ to select a shortcut such as Exposure Compensation or Self-timer. (You'll see different functions in different modes.)

NOTE: Reset Exposure Compensation to zero (0) when finished.

- 2 Press ▲▼ to change a setting.





Using the self-timer and burst

Use the self-timer when you want to be included in a picture or to ensure a steady Shutter button press. For best results, place the camera on a tripod or steady surface. You can turn on the self-timer using a shortcut (see page 16) or these steps:

- 1 Turn on the camera, then press ► to select Shortcuts.
- 2 Press the Menu  button. Press ▲▼ to choose Self-timer, then press OK.
- 3 Press ▲▼ to choose a Self-timer setting:

Off—Self-timer is turned off.

10 Seconds— A picture is taken after a 10-second delay (so you have time to get into the scene).

2 Seconds— A picture is taken after a 2-second delay.

2 Picture Timer— The first picture is taken after a 10-second delay. A second picture is taken 8 seconds later.

Burst On—Take several pictures in succession

- 4 Compose the scene. Press the Shutter button all the way down.

The camera takes the picture/pictures after the delay.

To take a video after a 2- or 10-second delay, use the same procedure.

Using the camera under water

The camera does not float. To prevent it from sinking, secure it to your wrist with the wrist strap (provided). You can also purchase a floating wrist strap at www.kodak.com/go/accessories. Tightly close and latch all doors to keep the camera waterproof. **Do not open doors in water or when hands are wet.** Waterproof integrity may be compromised if the camera is dropped.



IMPORTANT: Camera is waterproof up to 5 meters (16 ft)

For the best focus and color balance under water:

- 5 Press ▲▼ to change to Underwater mode **H₂O**, then press OK.
- 6 Press ◀▶ to choose Underwater Pictures or Underwater Videos, then press OK.
- 7 When finished taking underwater videos/pictures, go back to Step 1 and choose a non-underwater setting.

After using the camera in water

IMPORTANT: Verify that inner and outer battery doors are tightly closed before exposing to water.



- Wipe off water or debris within 1 hour of submersion in water. If the camera was used in chemically treated water or saltwater, rinse it in fresh water, then dry with a soft towel.
- If water has entered the camera, remove the card. Allow camera to air-dry for at least 24 hours before using.

Keep doors watertight [see page 5](#)

4

Sharing pictures/videos

Sharing through social networks

It's never been easier to share pictures on your favorite social networking sites.

IMPORTANT: *To use the social networking features, you must first install and set up KODAK Software. (see page 7).*



1 Press the Review  button, then   to find a picture.

2 Press the Share button.

If it's your first time, a Help screen appears.

3 Press   to choose a social networking site, then press OK.

A check mark appears. Repeat this step to choose more sites. (You can press OK again to remove a check mark.)

4 To share other videos/pictures, repeat steps 2 and 3. When finished, press   to choose Done, then press OK.

When you connect the camera to your computer, these pictures/videos are sent to the sharing destinations you chose (see page 8).

NOTE: If you send pictures to the same destinations each time, you may want to use the Fast Share feature, found in Share Button Settings (see page 36).

Manage email addresses and KODAK PULSE Digital Frames



You can add, edit, or delete email addresses and KODAK PULSE Digital Frames on your camera.

- 1 Press the Share button. Press ▲▼ to choose Manage Email Addresses (or Manage Frames), then press OK.
- 2 To add an email address or frame, press ▲▼ to choose Add Email or Add Frame, then press OK. Use the on-screen keyboard to make the addition. See [page 21](#). (Example: JohnDoe@domain.com)
To edit an email address or a KODAK PULSE Digital Frame, press ▲▼ to choose the address's nickname or the frame, then press OK. Use the on-screen keyboard to make edits.
To delete an email address or frame, choose Delete Email or Delete Frame, then press OK. Press ▲▼ to choose the address or frame, then press OK so that a check mark appears. Press ▲▼ to choose Delete, then press OK.
- 3 When finished, press ▲▼ to choose Done, then press OK.

NOTE: You can also set up email addresses using the KODAK Share Button App ([see page 9](#)).

Tagging pictures/videos with keywords

You can tag pictures/videos with a keyword to make them easy to find, later. You can tag pictures using a shortcut ([see page 16](#)) or these steps:

- 1 Press the Review  button, then ◀▶ to find a picture.
- 2 Press the Menu  button. Press ▲▼ to choose Keyword Tag, then press OK.
- 3 Press ▲▼ to choose an existing keyword or New Keyword (see [Using the keyboard](#)) to add a new one, then press OK.
- 4 Press ◀▶ to add keywords to other pictures. When finished, press ▲▼ to choose Done, then press OK.

To return to picture-taking mode, press the Review  button.

Using the keyboard

The keyboard appears when you need it.

- 1 Press ◀▶ ▲▼ to choose a letter, then press OK.
- 2 When finished, press ▲▼ to choose OK, then press OK.

Marking pictures/videos for emailing

It's simple to mark pictures/videos so that they're ready to email using KODAK Software. First, create a new email address. (See [page 20](#).)

- 1 Press the Review  button. Press ◀▶ to find a picture.
- 2 Press the Share button.
- 3 Press ▲▼ to find a nickname, then press OK.

To mark other pictures/videos with the same address, press ◀▶, then press OK.

To send the pictures/videos to more than one address, repeat this step.

To return to picture-taking mode, press the Review  button.

When you transfer the marked pictures/videos to your computer, the software prompts you to send the pictures/videos.



NOTE: You can also set up email addresses using the KODAK Share Button App ([see page 9](#)).

5

Reviewing and editing

Reviewing pictures/videos





- 1 Press the Review  button.
- 2 Press  for previous/next picture/video.
 - To exit, press the Review button.
 - To view pictures/videos as thumbnails, press the Wide Angle (W) button. (For more information, see [page 24](#).)

Playing a video





Press OK to play a video. Press OK to pause/resume. During playback:

- Press  to play at 2X speed; press again for 4X.
- Press  to reverse at 2X speed; press again for 4X.

NOTE: Audio can be heard when the video is played on a computer or when the camera is connected to a TV ([see page 28](#)).

Deleting pictures/videos

- 1 Press the Review  button.
- 2 Press  for previous/next picture/video.
- 3 Press the Delete button.
- 4 Follow the screen prompts.



NOTE: To delete protected pictures/videos, remove protection before deleting. (See [page 23](#).)



Using the undo delete picture feature

If you accidentally delete a video/picture, you may be able to use Undo Delete to retrieve it. After you select a video/picture for deletion, another screen appears. On that screen, select Undo Delete. The video/picture is no longer deleted.

NOTE: This feature is only available immediately after you delete a picture.

Protecting pictures/videos from deletion

- 1 Press the Review  button.
- 2 Press the Menu  button.
- 3 Press  to choose Protect, then press OK.
- 4 Press  to choose Protect again, then press OK.

A check mark indicates that the picture/video is protected. Pressing OK again removes the check mark. Press  to protect other pictures/videos, or press  to choose Done, then press OK.

- Press the Menu  button to exit the menu.



CAUTION:

Formatting an SD or SDHC Card deletes all (including protected) pictures/videos.

Viewing pictures/videos in different ways

Magnifying a picture



- 1 Press Telephoto (T) to magnify 2X–8X.
- 2 Press ◀▶ ▲▼ to view other parts of a picture.
 - Press OK to return to 1X.



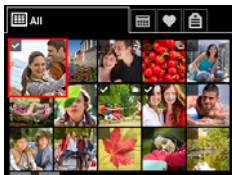



Viewing as thumbnails



- 1 Press the Review  button.
The camera shows the last picture/video that was taken.
- 2 Press the Wide Angle (W) button to view pictures/videos as thumbnails. (Press it again to see more, smaller thumbnails.)
To view all pictures/videos, choose the All tab.
To sort by favorites, date, or keywords, press ◀▶ and choose the appropriate tab.
- 3 To see a single picture/video, press ◀▶ ▲▼ to choose it. Then press the Telephoto (T) button.
 - To select multiple pictures/videos, see [page 32](#).
 - Press the Review button to exit Review.

A smarter way to find and enjoy your pictures

Tag pictures with a keyword ([page 20](#)) to make them easy to find, later.

- 1 Press the Review  button.
- 2 Press the Wide Angle (W) button to view pictures by thumbnail (or choose View Thumbnails shortcut).
- 3 Press   to choose the All, Date, Favorite, or Keyword tab.
- 4 Press     to choose a picture or picture stack, then press OK.

Press Telephoto (T) see pictures in a stack or to see an individual picture. Press Wide Angle (W) to see thumbnails or picture stacks. To return to picture-taking mode, press the Review  button.

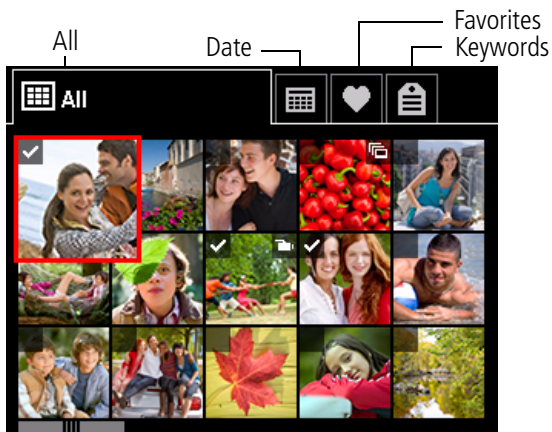

Understanding the review icons

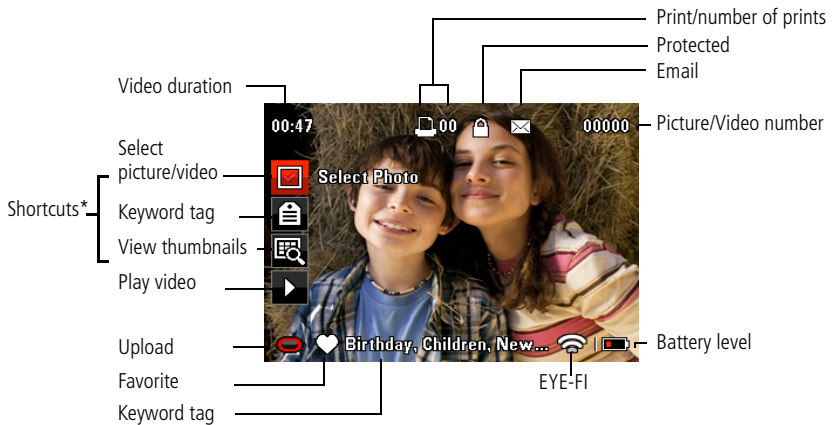









* For more about shortcuts, see [page 16](#).

Creating a slide show

Use Slide Show to display your pictures/videos on the LCD. You can play all pictures/videos, or choose pictures to include in the slide show.







Make a slide show

- 1 Press the Review  button. Select pictures (see [page 32](#)). If you select no pictures, all pictures are shown.
- 2 Press the Menu  button, then   to choose the Review tab.
- 3 Press   to choose Slide Show, then press OK.
- 4 Press   to choose Begin Show, then press OK.

Each picture/video is displayed once. To interrupt the slide show, press OK. You can also determine the slide interval duration.

Play a slide show loop

When you turn on Loop, the slide show is continuously repeated.

- 1 On the Slide Show menu, press   to choose Loop, then press OK.
- 2 Press   to choose On, then press OK.
- 3 Press   to choose Begin Show, then press OK.

The slide show repeats until you press OK or until the batteries are exhausted.

Displaying pictures/videos on a television







You can display pictures/videos on a television, computer monitor, or any device equipped with a video input. To connect the camera directly to a television, use an A/V cable (may be sold separately). On your TV, select the source that corresponds to the camera cable input.



Purchase accessories www.kodak.com/go/accessories

NOTE: To control the audio portion of a video, use the camera or TV (or TV remote control) volume controls. Verify that the Video Out setting (NTSC or PAL) is correct ([see page 36](#)). The slide show stops if you connect or disconnect the cable while the slide show is running. Image quality may appear lower on a television screen than on a computer monitor or when printed.









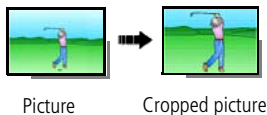

Using the menu button in review

- 1 Press the Review  button, then press the Menu  button.
- 2 Press   to choose a tab:
 - **Review**
 - **Edit**
 - **Setup**
- 3 Press   to choose a setting, then press OK.
- 4 Choose an option, then press OK.

Cropping pictures

You can crop a picture so that only the desired portion of the picture remains.



- 1 Press the Review  button, then   to find a picture to crop.
- 2 Press the Menu  button, then   to choose the Edit tab. Choose Crop, then press OK.
- 3 Press Telephoto (T) to shrink the crop area or Wide (W) to enlarge it. Press     to move the crop box. When satisfied with the crop box, press OK.
- 4 Follow the screen prompts.

The picture is cropped. (The original is saved.) Cropped pictures cannot be cropped again on the camera. To return to picture-taking mode, press the Review  button.





Editing videos

You can do incredible things with your videos.

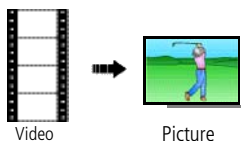
Making a picture from a video

You can choose a single frame from a video, then make a picture suitable for a 4 x 6-inch (10 x 15 cm) print.







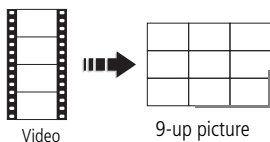

- 1 Press the Review  button, then  to find a video.
- 2 Press the Menu  button, then  to choose the Edit tab. Choose Make Picture, then press OK.
- 3 Follow the screen prompts.

A picture is created. (The original video is saved.) To return to picture-taking mode, press the Review  button.

Making a video action print

From a video, you can make a 9-up picture, suitable for a 4 x 6-inch (10 x 15 cm) print.







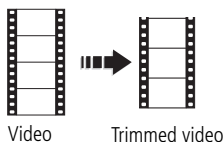

- 1 Press the Review  button, then   to find a video.
- 2 Press the Menu  button, then   to choose the Edit tab. Choose Action Print, then press OK.
- 3 Choose an option, then press OK.

A 9-up picture is created. To return to picture-taking mode, press the Review  button.

Trimming a video

You can remove an unwanted start or end from a video, saving only the desired portion.



- 1 Press the Review  button, then   to find a video.
- 2 Press the Menu  button, then   to choose the Edit tab. Choose Trim, then press OK.
- 3 Follow the screen prompts.

The video is trimmed. (You can save it as a new video or replace the original.) To return to picture-taking mode, press the Review  button.

Selecting multiple pictures/videos

Use the multi-select feature when you have two or more pictures/videos to print, transfer, delete, etc. Multi-select is used most effectively with thumbnails, [page 24](#).

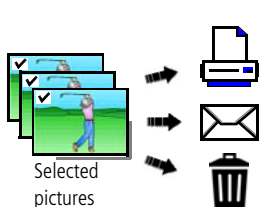











- 1 Press the Review  button, then   (and   if you're in multi-up mode) to find a picture/video.
- 2 Press OK to select pictures/videos.

A check mark appears on the picture. (Press OK again to remove a check mark.) You can now print, transfer, delete, etc. the selected pictures.







Rotating pictures

You can rotate a picture to portrait or landscape orientation.

- 1 Press the Review  button, then   to find the previous/next picture.
- 2 Press the Menu  button. Press   to highlight the Edit tab.
- 3 Press   to highlight Rotate Picture, then press OK.
- 4 Press   to highlight an option:
 - **Rotate Right**—rotates the picture 90 degrees clockwise.
 - **Rotate Left**—rotates the picture 90 degrees counterclockwise.
- 5 Press OK.
- Press the Review  button to return to Picture-taking mode.

Using KODAK PERFECT TOUCH Technology





KODAK PERFECT TOUCH Technology helps ensure better, brighter pictures.

- 1 Press the Review  button, then  for previous/next picture.
 - 2 Press the Menu  button, then  to highlight the Edit tab. Highlight PERFECT TOUCH Tech, then press OK.
The enhancement is previewed. Press  to view other parts of the picture.
 - 3 Choose Continue or Cancel.
 - 4 Press OK. Follow the screen prompts to replace the original picture or to save the enhanced picture as a new one.
- Press the Review  button to return to Picture-taking mode.

NOTE: You cannot apply PERFECT TOUCH Technology to videos or to pictures to which PERFECT TOUCH Technology is already applied.

Adding a date stamp

You can add a stamp—showing the date/time that it was taken—to a picture.

- 1 Press the Review  button, then  to find a picture.
 - 2 Press the Menu  button, then  to choose the Edit tab. Choose Date Stamp, then press OK.
The date/time is added to the picture.
- Press the Review  button to return to Picture-taking mode.





6

Doing more with your camera

Using the menu button to change settings in picture taking mode

You can change settings to get the best results from your camera.

NOTE: Some modes offer limited settings. Some settings remain until you change them; others, until you change modes or turn off the camera.

- 1 Press the Menu  button.
- 2 Press   to choose a tab:
 - **Capture** for the most common picture-taking settings
 - **Setup** for other camera settings
- 3 Press   to choose a setting, then press OK.
- 4 Choose an option, then press OK.

Using the Capture tab

Settings	More information
Picture Size Choose a picture resolution.	14 MP (4352 x 3264)
Exposure Compensation Make a picture lighter or darker. To access this feature with a shortcut, see page 16 .	+/-2.0 EV with 1/3 EV step
ISO Speed Control the camera sensitivity to light.	Auto: 80–360; Manual: 80, 100, 200, 400, 800, 1250

Settings	More information
Self-timer Choose Self-timer feature.	10 seconds, 2 seconds, 2 picture timer
Color Mode Choose color tones. Unavailable in Video and Auto modes.	Vivid, Full, Basic, Black & White, Sepia
White Balance Choose your lighting condition.	Auto —Automatically corrects white balance. Ideal for general picture taking. Daylight —For pictures in natural lighting. Tungsten —Corrects the orange cast of incandescent light bulbs. Ideal for indoor pictures under tungsten or halogen lighting without flash. Fluorescent —Corrects the green cast of fluorescent lighting. Ideal for indoor pictures under fluorescent lighting without flash. Open Shade —For pictures in shade in natural lighting.
Exposure Metering	Face priority (default) Multi-pattern Center-weight
Sharpness Control picture sharpness or softness.	Sharp or Normal

Video settings

Settings	More information
Self-timer Choose Self-timer feature.	Off 10 Seconds 2 Seconds

Using the Setup menu

Use Setup to customize other camera settings.

Settings	More information
Date & Time	Set date and time.
Share Button Settings	<p>Fast Share—Choose Fast Share destinations. Then, when you press and hold the Share button for more than 1 second, the picture is sent to those destinations.</p> <p>Customize Text—Turn the ability to customize text On/Off.</p> <p>Default Title—Type a standard title or accept the default title: “Sharing from my camera.”</p> <p>Default Message—Type a standard message or accept the default title: “Shared using the KODAK Share Button App.”</p>
Language	Choose your language.
LCD Brightness Choose LCD brightness during picture/video capture.	<p>High Power—Brighter LCD; uses more battery power.</p> <p>Power Save—Dimmer LCD; uses less power.</p>
Date Stamp	Set the date and time.
Camera Sounds Choose whether to play a sound during certain events or have all sounds off.	<p>All On</p> <p>Shutter Only</p> <p>All Off</p>
Video Out Choose the regional setting that lets you connect the camera to a television or other external device.	<p>NTSC—Used in North America and Japan; most common format.</p> <p>PAL—Used in Europe and China.</p>
Shortcut Icons	Select a shortcut to a feature.

Settings	More information
Reset Camera Reset settings to their default.	Reset All Camera Settings —Settings revert to their factory defaults. Reset Startup Application —Resets camera to startup mode to allow KODAK Software download.
Computer Connection Choose which application is downloaded or launched when you connect the camera to the computer.	KODAK Software Other Application (APPLE IPHOTO, etc.) IMPORTANT: <i>To enable the camera Share button for email and social network sharing, you must install and set up the KODAK Share Button App (see page 7).</i>
Format  CAUTION: Formatting deletes all pictures/videos, including those that are protected. Removing a card during formatting may damage the card.	Memory Card —Deletes everything on the card; formats the card. Cancel —Exits without making a change.
KODAK Camera Software	View the URL to download KODAK Software.
Eye-Fi Turn off or turn on the Eye-Fi Card. Applies only if an Eye-Fi Card is inserted.	On Off
About	View camera information.

7

Transferring, printing pictures

When you transfer pictures/videos to your computer, any that you tagged for emailing or sharing on social networking sites are emailed or shared.

You can transfer in 2 ways:

- Using the included USB cable (see below)
- Using an optional EYE-FI Card (see page 43)

IMPORTANT: To enable the camera Share button for email and social network sharing, you must install and set up the KODAK Share Button App (see page 7).

- 1 Turn off the camera.
- 2 Using the USB cable, connect the camera to a computer USB port. (Use only the cable included with this camera.) The camera turns on.
- 3 Follow the computer prompts to transfer pictures/videos to your computer.



NOTE: You can also use a card reader to transfer pictures/videos.

Download KODAK Software later

www.kodak.com/go/camerasw

Get Software help

www.kodak.com/go/support

To use this camera on more than one computer, use the Reset Startup Application feature

[see page 37](#)

Printing pictures

Direct printing with a KODAK All-in-One Printer

Your camera is compatible with PICTBRIDGE Technology, so you can print directly to PICTBRIDGE enabled Printers. You need a camera, a PICTBRIDGE enabled Printer, and a USB cable. Your camera must be set to Other Applications mode.

Connecting the camera to a KODAK All-in-One Printer

- 1 Turn off the camera and printer.
- 2 Connect the USB cable from the camera to the printer.

Printing from a KODAK All-in-One Printer

- 1 Turn on the printer. Turn on the camera.

The PictBridge logo appears, followed by the current picture and menu. (If no pictures are found, a message appears.) If the menu turns off, press any button to restore it.

- 2 Choose a printing option, then press OK.

Current Picture—Press ◀▶ to choose a picture.

Tagged Pictures—If your printer is capable, print pictures that you marked for printing.

Index Print—Print thumbnails of all pictures. (This option requires one or more sheets of paper.)

All Pictures—Print all pictures in internal memory or on a card.

NOTE: During direct printing, pictures are not permanently transferred or saved to the printer. To transfer pictures to your computer, see [page 38](#).

Purchase cables, accessories www.kodak.com/go/accessories

Disconnecting the camera from a KODAK All-in-One Printer

- 1 Turn off the camera and printer.
- 2 Disconnect the USB cable from the camera and the printer.

Ordering prints online



KODAK Gallery (www.kodakgallery.com) makes it easy to:

- Upload your pictures.
- Edit, enhance, and add borders to your pictures.
- Store pictures, and share them with family and friends.
- Have prints, photo greeting cards, frames, and albums delivered to your door.

Printing from an SD or SDHC Card

- Automatically print tagged pictures when you insert your card into a printer with an SD/SDHC Card slot. See your printer user guide for details.
- Make prints at an SD/SDHC Card-capable KODAK Picture Kiosk. Go to www.kodak.com/go/picturemaker.
- Take the card to your local photo retailer for professional printing.

Marking your pictures for print

- 1 Press the Review  button. Press ◀▶ to find a picture.
- 2 Press the Menu  button.
- 3 Press ▲▼ to choose Print, then press OK.
- 4 Press ▲▼ to choose the number of copies.

Optional: You can apply a print quantity to other pictures. Press ◀▶ for previous/next. Repeat this step until the desired print quantity is applied to each picture.

- 5 Press OK.

To return to picture-taking mode, press the Review  button.

8

Using an EYE-FI Card

This chapter pertains only if you're using an EYE-FI Card.

An Eye-Fi Card stores pictures in the same way that an SD/SDHC Card does. It also has a built-in Wi-Fi antenna that uses your Wi-Fi network to transfer pictures from your camera to your computer or mobile device.

IMPORTANT: Choose an EYE-FI X2 Card or higher, with a firmware version of 4.5174 or higher. View and update firmware using the Eye-Fi Center Software that accompanies the card.

Storing pictures on an EYE-FI Card

To set up and use the EYE-FI Card and EYE-FI Center Software, follow the EYE-FI documentation to set up the card. For further EYE-FI support, go to support.eye.fi.



CAUTION:

If you're using an EYE-FI Card in this camera, it's critical that you disable (do not turn on) Endless Memory Mode in EYE-FI Center Software.



- 1 Turn off the camera, then open the door.
- 2 Insert a card until it clicks.

To remove a card, press and release it.

IMPORTANT: When you turn on the camera, it checks to see if a card is inserted. If pictures/videos are detected in internal memory, the camera prompts you to move them to the card. New pictures/videos are stored on the card.

Get support for EYE-FI Cards and Software support.eye.fi

Sharing pictures using an EYE-FI Card

NOTE: You can share 1 picture/video at a time, and you cannot email pictures/videos.

- 1 Press the Share button.
- 2 Press ◀▶ ▲▼ to find a picture or video.
- 3 Tap desired sharing destinations. (Tap again to remove a check mark. Tap the More icon ⓘ to see additional sharing destinations.)
- 4 When finished, Tap Done.

IMPORTANT: *For the best reception when transferring pictures to a computer or mobile device, the rear of the camera should face the Wi-Fi access point.*

- 5 When you're in range of your Wi-Fi network, turn **on** the camera.
The picture/video is sent to the sharing destinations you chose.

Transferring pictures using an EYE-FI Card

You can transfer pictures from your camera to a computer or to a mobile device that's running the EYE-FI App.



CAUTION:

If you're using an EYE-FI Card in this camera, it's critical that you disable (don't turn on) Endless Memory Mode in EYE-FI Center Software.

- 1 On your computer, launch the EYE-FI application.
- 2 In picture-taking mode, press Menu.
- 3 Press ▲▼ to select EYE-FI, then press OK.
- 4 We recommend the Selective Share setting:

Auto—All pictures are automatically sent to your computer. All pictures are shared to your social networking sites.

Selective Share—All pictures are automatically sent to your computer. Only pictures that you tagged to share are sent to your social networking sites.

Selective Transfer—Only pictures that you choose are sent to your computer. Only pictures that you tagged to share are sent to your social networking sites.

(See more about tagging pictures on [page 20](#).)

- 5 When you're in range of your known Wi-Fi network, turn **on** the camera to transfer pictures to your computer or mobile device.

Icon	Meaning
	EYE-FI is idle, waiting to be in range of a Wi-Fi zone.
	EYE-FI is on the network and transferring pictures to computer.
	Error
	EYE-FI is off.

Get EYE-FI support

support.eye.fi

Other EYE-FI Information

- **It's critical that you disable (do not turn on) Endless Memory Mode in EYE-FI Center Software.**
- As of December 2010, EYE-FI Cards are permitted only in the countries and regions in which they were purchased. You may be held liable due to local restrictions.
- The EYE-FI Card has a wireless LAN function. Do not insert the EYE-FI Card where wireless LAN is prohibited, such as while aboard an airplane or in a hospital.
- Even when you set EYE-FI to off, the card may transmit radio waves.
- The card may become warm during use. This is normal.
- Battery life is reduced when using an EYE-FI Card.
- For the best reception when transferring pictures to a computer or mobile device, the rear of the camera should face the Wi-Fi access point.

9

Troubleshooting

Camera problems

Status	Solution
Camera does not turn on	<ul style="list-style-type: none">■ Make sure the batteries are installed correctly (see page 3).■ Make sure batteries are new. If batteries are rechargeable, make sure they are fully charged (see charger documentation).
Camera does not turn off	
Camera buttons and controls do not function	
Condensation on the lens or LCD.	Condensation may occur when the camera is subjected to temperature or humidity changes. To correct, turn off the camera, open all doors, and wait until condensation clears.
In Review, a blue or black screen is displayed instead of a picture	<ul style="list-style-type: none">■ Transfer <i>all</i> pictures to the computer (see page 38).■ Take another picture.
Pictures remaining number does not decrease after taking a picture	<ul style="list-style-type: none">■ Continue taking pictures. The camera is operating normally. (The camera estimates the number of pictures remaining after each picture is taken, based on picture size and content.)
Flash does not fire	<ul style="list-style-type: none">■ Check the flash setting, and change as needed (see page 13). <p>NOTE: The flash does not fire in all modes.</p>
Memory card is almost or entirely full	<ul style="list-style-type: none">■ Transfer the pictures to the computer (see page 38).■ Delete pictures from the card (see page 23) or insert a new card.

Status	Solution
Battery life is short	<ul style="list-style-type: none"> ■ Make sure the correct battery type is installed (see page 51). ■ Insert new/charged batteries (see page 3). ■ See Extending battery life, page 54. ■ Adjust LCD Brightness (see page 36). ■ Turn off the Eye-Fi feature when not in use (see page 41).
Cannot find the desired picture/video	<ul style="list-style-type: none"> ■ To view pictures stored on a memory card, see page 22.
You cannot take a picture	<ul style="list-style-type: none"> ■ Turn the camera off, then on again. ■ Depress the Shutter button all the way (see page 10). ■ Insert new/charged batteries in the correct orientation (see page 3). ■ Memory is full. Transfer pictures to the computer (see page 38), delete pictures (see page 23), or insert another card.
Memory card not recognized or camera freezes with card	<ul style="list-style-type: none"> ■ Remove and reinsert the card (see page 4). <p>IMPORTANT: <i>Insert a card until it clicks.</i></p> <ul style="list-style-type: none"> ■ Card may be corrupted. Format the card in the camera (see page 37). ■ Use another memory card. Only SD or SDHC Cards are supported.
The camera gets wet inside	<ul style="list-style-type: none"> ■ Do not turn on the camera. ■ Wipe off water or debris within 1 hour of submersion in water. If the camera was used in chemically treated water or saltwater, rinse it in fresh water, then dry with a soft towel. ■ Remove the batteries and card. ■ Open all doors on camera. ■ Allow camera to dry for at least 24 hours. ■ In the future, keep doors watertight (see page 5).
No sound when reviewing video	<p>Sound captured in a video can only be heard when the video is played on a computer or when the camera is connected to a TV (see page 28).</p>

Computer/connectivity problems

Status	Solution
Computer does not communicate with the camera	<ul style="list-style-type: none"> ■ Turn off the camera, then turn it back on. ■ Make sure the batteries are charged and installed correctly (see page 3). ■ Make sure the KODAK Camera USB Cable, Micro B / 5-Pin is connected to the camera and directly to the computer (not through a USB hub). See page 7. Then turn on the camera. <p>IMPORTANT: Use only the cable included with this camera!</p> <ul style="list-style-type: none"> ■ See KODAK Software Help at www.kodak.com/go/camerasw.

Picture quality problems

Status	Solution
Picture is not clear	<ul style="list-style-type: none"> ■ Clean the lens (see page 52). ■ Place the camera on a flat, steady surface or use a tripod (especially in low light). ■ Use a larger picture size (see page 34).
Picture is too dark	<ul style="list-style-type: none"> ■ Adjust the Exposure Compensation (see page 16) ■ Reposition the camera for more available light. ■ Use Fill flash (see page 13) or change your position so light is not behind the subject. ■ Move so that the distance between you and the subject is within the effective flash range (see Camera specifications starting on page 50).
Picture is too light	<ul style="list-style-type: none"> ■ Adjust the Exposure Compensation (see page 16) ■ Reposition the camera to reduce the amount of available light. ■ Turn the flash off (see page 13). ■ Move so that the distance between you and the subject is within the effective flash range (see Camera specifications starting on page 50).

Status	Solution
Underwater videos are off-color.	Use Underwater mode (see page 14).

Direct printing (PICTBRIDGE enabled printer) problems

Status	Solution
The Direct printing menu interface turns off	<ul style="list-style-type: none"> ■ Press any camera button to redisplay the menu.
Cannot print pictures	<ul style="list-style-type: none"> ■ Make sure there is a connection between the camera and the printer (see page 39). ■ Make sure the printer and the camera have power.
Camera or printer displays an error message	<ul style="list-style-type: none"> ■ Follow the prompts to resolve the issue.

EYE-FI problems

Status	Solution
Get support for EYE-FI Cards and Software.	Go to http://support.eye.fi
EYE-FI Card is not working in this camera.	<ul style="list-style-type: none"> ■ Choose an EYE-FI X2 Card or higher, with a firmware version of 4.5174 or higher. View and update firmware using the Eye-Fi Center Software that accompanies the card. ■ The camera must be turned on to transfer pictures to the computer or mobile device.
EYE-FI endless memory is not working.	<p> CAUTION: If you're using an EYE-FI Card in this camera, it's critical that you disable (don't turn on) Endless Memory Mode in EYE-FI Center Software.</p>

Status	Solution
EYE-FI Card gets warm.	■ This is normal.
Camera battery life is shorter.	■ Battery life is reduced when using an EYE-FI Card.
Transferring pictures is slow using the EYE-FI Card.	■ For the best reception when transferring pictures to a computer or mobile device, the rear of the camera should face the Wi-Fi access point.

Getting help on the Web

Get support for your product (FAQs, troubleshooting information, arrange for repairs, etc.)	www.kodak.com/go/c135support
Purchase camera accessories	www.kodak.com/go/accessories
Download the latest camera firmware and software	www.kodak.com/go/c135downloads
Chat, email, write, or phone Kodak (Chat not available in all languages)	www.kodak.com/go/contact
Download KODAK EASYSHARE Software	www.kodak.com/go/easysharesw (or see Help in EASYSHARE Software)
Get information on KODAK All-in-One Printers	www.kodak.com/go/inkjet

10 Appendix

Camera specifications

CCD—1/2.3-type

Effective pixels—14 MP (4352 x 3264)

LCD—2.4 in. (6.1 cm) LCD; 112 pixels; 4:3 aspect ratio

Image storage—Optional Class 4 or higher SD/SDHC Card  (or EYE-FI X2 Card or higher with a firmware version of 4.5174 or higher.) The SD logo is a trademark of the SD Card Association. Maximum supported card size: 32 GB

Taking lens—f/4.5; 35 mm equivalent: 35 mm

Lens protection—Built-in

Digital zoom—5X continuous

Shutter speed—1/8–1/1400 seconds

Long time exposure—0.5–8 seconds

ISO speed—Auto: 80–360; Manual: 80, 100, 200, 400, 800, 1250

Exposure compensation—+/-2.0 EV with 1/3 EV step

White Balance—Auto, Daylight, Tungsten, Fluorescent, Open Shade

Electronic Flash—Auto flash; Auto, Fill, Red Eye, Off; **TBD**: Guide No.6.5 (m) working range @ ISO 360: 0.3 -2.45m

Self-timer mode—10 seconds, 2 seconds, 2 picture timer

Capture modes—Auto, Scene modes, Video, Underwater still, Underwater video

Image file format—

Still: EXIF 2.3 (JPEG compression); file organization DCF

Video: AVI (CODEC Motion JPEG; audio: μ -Law)

Picture size—

- 14 MP (4:3) 4288 x 3216 pixels
- 12 MP (3:2) 4288 x 2848 pixels
- 10 MP (16:9) 4288 x 2416 pixels
- 6 MP (4:3) 2880 x 2160 pixels
- 3 MP (4:3) 2048 x 1536 pixels

Color modes—Vivid, Full, Basic, Black & White, Sepia

Sharpness modes—Sharp, Normal

Video capture—4 GB maximum; VGA (640 x 480 @ 30 fps)

Communication with computer—USB 2.0 high speed -> full speed (PIMA 15740 protocol); via KODAK Camera USB Cable, Micro B / 5-Pin

Video output—NTSC or PAL

Microphone—Yes

Speaker—No

Beeper—Yes

PICTBRIDGE support—Yes

Power—KODAK MAX Alkaline Batteries AA; KODAK Ni-MH Rechargeable Digital Camera Batteries AA, Lithium batteries AA

Tripod mount—1/4 inch

Size—92.2 x 66.6 x 29.4 mm (3.6 x 2.6 x 1.1 in.) @ power off

Weight—175 g (6.1 oz) with batteries and card

Operating temperature—0–40° C (32–104° F)

Waterproof capability—Conforms to IEC60529 IPX8, up to 5meters (16 ft)

Dust proof capability—Conforms to IEC60529 IP6X

Care and maintenance

- If you suspect water has gotten inside the camera, remove the batteries and card. Allow all components to air-dry for at least 24 hours before using the camera.
- Blow gently on the lens or LCD to remove dust and dirt. Wipe gently with a soft, lint-free cloth or an untreated lens-cleaning tissue. Do not use cleaning solutions unless designed specifically for camera lenses. Do not allow chemicals, such as suntan lotion, to contact painted surfaces.
- Service agreements may be available in your country. Contact a dealer of KODAK Products for more information.
- For digital camera disposal or recycling information, contact your local authorities. In the US, go to the Electronics Industry Alliance site at www.eiae.org or Kodak at www.kodak.com/go/c135support.
- In water, do not use below a depth of 5 meters (16 ft).
- Do not open/close camera doors in water.
- The camera does not float. To prevent it from sinking, secure it to your wrist with the wrist strap (provided). You can also purchase a floating wrist strap at www.kodak.com/go/accessories. Tightly close and latch all doors to keep the camera waterproof. **Do not open doors in water or when hands are wet.** Waterproof integrity may be compromised if the camera is dropped.
- If water has entered the camera, remove the card. Allow all components to air-dry for at least 24 hours before using the camera.
- If the camera was used in chemically treated water or saltwater, rinse it in fresh water, then use a soft towel to dry it.
- Wipe off dirt or sand from the door seals—debris could compromise the seal and cause a leak when in water.

Upgrading your software and firmware

Download the latest versions of KODAK Software and the camera firmware (the software that runs on the camera). Go to www.kodak.com/go/c135downloads.

Storage capacities

The LCD displays the approximate number of pictures (or minutes/seconds of video) remaining. For average SD Card capacities, go to www.kodak.com/go/SDcapacities. Actual storage capacity varies depending on subject composition, card size, and other factors. You may be able to store more or fewer pictures and videos.

Important safety instructions



CAUTION:

Do not disassemble this product; there are no user-serviceable parts inside. Refer servicing to qualified service personnel. KODAK AC Adapters and Battery Chargers are intended for indoor use only. The use of controls, adjustments, or procedures other than those specified herein may result in exposure to shock and/or electrical or mechanical hazards. If the LCD breaks, do not touch the glass or liquid. Contact Kodak customer support.

- The use of an accessory that is not recommended by Kodak may cause fire, electric shock, or injury. For approved accessories, go to www.kodak.com/go/accessories.
- Use only a USB-certified computer equipped with a current-limiting motherboard. Contact your computer manufacturer if you have questions.
- If using this product in an airplane, observe all instructions of the airline.
- When removing the batteries, allow them to cool; they may be hot.
- Follow all warnings and instructions supplied by the battery manufacturer.
- Use only batteries approved for this product to avoid risk of explosion.
- Keep batteries out of the reach of children.

- Do not allow batteries to touch metal objects, including coins. Otherwise, a battery may short circuit, discharge energy, become hot, or leak.
- Do not disassemble, install backward, or expose batteries to liquid, moisture, fire, or extreme temperature.
- Remove the batteries when the product is stored for an extended period of time. In the unlikely event that battery fluid leaks inside the product, contact Kodak customer support.
- In the unlikely event that battery fluid leaks onto your skin, wash immediately with water and contact your local health provider. For additional health-related information, contact your local Kodak customer support.
- Go to www.kodak.com/go/reach for information about the presence of substances included on the candidate list according to article 59(1) of Regulation (EC) No. 1907/2006 (REACH).
- Dispose of batteries according to local and national regulations. Go to www.kodak.com/go/kes.
- Do not charge non-rechargeable batteries.
For more information on batteries, go to www.kodak.com/go/batterychart.

Battery replacement, battery life

Lithium batteries AA, KODAK MAX Alkaline Batteries AA: 200 pictures. Battery life per CIPA testing method. (Approx. number of pictures in Auto mode, using an SD Card.) Actual life may vary based on usage. For other compatible batteries, see the Power section in [Camera specifications, page 50](#).

Extending battery life

- Charge Ni-MH batteries when they are nearly depleted.
- Dirt on the battery contacts can affect battery life. Wipe the contacts with a clean, dry cloth before loading batteries in the camera.
- Battery performance is reduced at temperatures below 41° F (5° C). When using

your camera in cold weather, carry spare batteries and keep them warm. Do not discard cold batteries that do not work; when they return to room temperature, they may be usable.

Limited warranty

Kodak warrants its digital cameras and accessories (excluding batteries) to be free from malfunctions and defects in both materials and workmanship for the warranty period specified on your KODAK Product packaging. Retain the original dated sales receipt. Proof of purchase date is required with any request for warranty repair.

Limited warranty coverage

Warranty service is only available from within the country where the Products were originally purchased. You may be required to ship Products, at your expense, to the authorized service facility for the country where the Products were purchased. Kodak will repair or replace Products if they fail to function properly during the warranty period, subject to any conditions and/or limitations stated herein. Warranty service will include all labor as well as any necessary adjustments and/or replacement parts. If Kodak is unable to repair or replace a Product, Kodak will, at its option, refund the purchase price paid for the Product provided the Product has been returned to Kodak along with proof of the purchase price paid. Repair, replacement, or refund of the purchase price are the sole remedies under the warranty. If replacement parts are used in making repairs, those parts may be remanufactured, or may contain remanufactured materials. If it is necessary to replace the entire Product, it may be replaced with a remanufactured Product. Remanufactured Products, parts and materials are warranted for the remaining warranty term of the original Product, or 90 days after the date of repair or replacement, whichever is longer.

Limitations

This warranty does not cover circumstances beyond Kodak's control. This warranty does not apply when failure is due to shipping damage, accident, alteration, modification, unauthorized service, misuse, abuse, use with incompatible accessories or attachments, failure to follow Kodak's operation, maintenance or repacking instructions, failure to use items supplied by Kodak (such as adapters and cables), or

claims made after the duration of this warranty. Kodak makes no other express or implied warranty for this product. In the event that the exclusion of any implied warranty is ineffective under the law, the duration of the implied warranty will be the length of the express warranty period specified on your Kodak product packaging. The option of repair, replacement, or refund is Kodak's only obligation. Kodak will not be responsible for any special, consequential or incidental damages resulting from the sale, purchase, or use of this product regardless of the cause. Liability for any special, consequential or incidental damages (including but not limited to loss of revenue or profit, downtime costs, loss of the use of the equipment, cost of substitute equipment, facilities or services, or claims of your customers for such damages resulting from the purchase, use, or failure of the Product), regardless of cause or for breach of any written or implied warranty is expressly disclaimed.

Your rights

Some states or jurisdictions do not allow exclusion or limitation of incidental or consequential damages, so the above limitation or exclusion may not apply to you. Some states or jurisdictions do not allow limitations on how long an implied warranty lasts, so the above limitation may not apply to you. This warranty gives you specific rights, and you may have other rights which vary from state to state or by jurisdiction.

Outside the United States and Canada

In countries other than the United States and Canada, the terms and conditions of this warranty may be different. Unless a specific Kodak warranty is communicated to the purchaser in writing by a Kodak company, no warranty or liability exists beyond any minimum requirements imposed by law, even though defect, damage, or loss may be by negligence or other act.

Regulatory compliance

FCC compliance and advisory

This equipment has been tested and found to comply with the limits for a Class B digital device, pursuant to Part 15 of the FCC Rules. These limits are designed to provide reasonable protection against harmful interference in a residential

installation. This equipment generates, uses, and can radiate radio frequency energy and, if not installed or used in accordance with the instructions, may cause harmful interference to radio communications. However, there is no guarantee that interference will not occur in a particular installation. If this equipment does cause harmful interference to radio or television reception, which can be determined by turning the equipment off and on, the user is encouraged to try to correct the interference by one or more of the following measures: 1) reorient or relocate the receiving antenna; 2) increase the separation between the equipment and the receiver; 3) connect the equipment to an outlet on a circuit different from that to which the receiver is connected; 4) consult the dealer or an experienced radio/TV technician for additional suggestions. Any changes or modifications not expressly approved by the party responsible for compliance could void the user's authority to operate the equipment. Where shielded interface cables have been provided with the product or specified additional components or accessories elsewhere defined to be used with the installation of the product, they must be used in order to ensure compliance with FCC regulation.

Waste Electrical and Electronic Equipment/Battery disposal



In Europe: For human/environmental protection, it is your responsibility to dispose of this equipment and batteries at a collection facility established for this purpose (separate from municipal waste.) For more information, contact your retailer, collection facility, or appropriate local authorities; or go to www.kodak.com/go/recycle. Product weight: 174 g (6.1 oz) with batteries and card.



Canadian DOC statement

DOC Class B Compliance—This Class B digital apparatus complies with Canadian ICES-003.

Observation des normes-Classe B—Cet appareil numérique de la classe B est conforme à la norme NMB-003 du Canada.

CE

Hereby, Eastman Kodak Company declares that this KODAK Product is in compliance with the essential requirements and other relevant provisions of Directive 1999/5/EC.

Australian C-Tick**Korean Class B ITE**

B급 기기 (가정용 방송통신기기)	이 기기는 가정용(B급)으로 전자파적합등록을 한 기기로서 주로 가정에서 사용하는 것을 목적 으로 하며, 모든 지역에서 사용할 수 있습니다.
-----------------------	---

Russian GOST-R

Eastman Kodak Company
Rochester, NY 14650

Фотокамера изготовлена в Китае; остальные элементы -
АЮ-40 в соответствии с маркировкой.

China RoHS

环保使用期限 (EUP)

在中国大陆，该值表示产品中存在的任何危险物质不得释放，以免危及人身健康、财产或环境的时间期限（以年计）。该值根据操作说明中所规定的产品正常使用而定。

有毒有害物质或元素名称及含量标识表						
部件名称	有毒有害物质或元素					
	铅	汞	镉	六价铬	多溴联苯	多溴二苯醚
数码相机电路板元件	×	○	○	○	○	○
○：表示该有毒有害物质在该部件所有均质材料中的含量均在SJ/T 11363-2006规定的限量要求以下。 ×：表示该有毒有害物质至少在该部件的某一均质材料中的含量超出SJ/T 11363-2006规定的限量要求。						



USB 数据线

Index

A

- A/V out, 28
- about this camera, 37
- accessories
 - battery, 54
 - buying, 49
 - EYE-Fi Card, 41
 - SD/SDHC Card, 4
- add keywords, 20
- add keywords, names, 21
- auto, 14
 - enhancement, 33

B

- backlight, 15
- battery
 - expected life, 54
 - loading, 3
 - purchase, 12
 - status, 12
 - types, 54
- beach, 15
- button
 - delete, 11
 - zoom, 13

C

- cable
 - audio/video, 28
- camera sounds, 36
- Canadian compliance, 57
- card

- EYE-Fi, 41
- care and maintenance, 52
- children, 15
- clock, setting, 6
- color mode, 35
- computer
 - connect camera, 38
 - transfer to, 38
- computer connection setting, 37
- connector, USB / A/V, 28
- copy pictures
 - to computer, 38
- cropping pictures, 29
- customize camera, 36

D

- date setting, 6
- date/time stamp, 33
- deleting
 - during quickview, 11
 - from internal memory, 23
 - from SD/SDHC Card, 23
 - protecting pictures, videos, 23
- displaying slide show, 27
- disposal, recycling, 52
- download
 - KODAK Software, 38
- download pictures, 38

E

- edit videos, 30
- emailing pictures, videos, 21

expected battery life, 54
exposure compensation, 34
external video device
 viewing pictures, videos, 28
EYE-FI
 Card, 41

F

FCC compliance, 56
find pictures, 25
fireworks, 15
firmware, upgrading, 53
flash, using, 13
flower, 15
format, 37

G

guidelines, battery, 54

H

help
 Web links, 45

I

icons, modes, 14
install
 EYE-FI Card, 41
 software, 7
installing
 battery, 3
 SD/SDHC Card, 4
ISO speed, 34

K

keyboard, 20, 21

KODAK EASYSHARE Software
 upgrading, 53
KODAK PERFECT TOUCH
 Technology, 33
KODAK Software, download, 38
Kodak Web sites, 45

L

language, 36
LCD
 brightness, 36
 reviewing pictures, 22
 reviewing videos, 22
LCD brightness, 36
lens
 cleaning lens, 52
load
 EYE-FI Card, 41
loading
 battery, 3
 SD/SDHC Card, 4
locate pictures, 25

M

magnify a picture, 24
maintenance, camera, 52
make picture from video, 30
marking
 for email, 21
memory
 inserting card, 4
memory card, 41
menu settings, 34
modes, 14

- backlight, 15
- beach, 15
- children, 15
- fireworks, 15
- flower, 15
- night portrait, 15
- scene (SCN), 15
- modes, capture
 - auto, 14
- multiple selections, 32
- multi-up, 24

N

- night portrait, 15

O

- online prints, ordering, 40

P

- PERFECT TOUCH Technology, 33
- PICTBRIDGE enabled printer, 39
- picture size, 34
- pictures
 - adding date/time stamp, 33
 - cropping, 29
 - emailing marked, 21
 - KODAK PERFECT TOUCH, 33
 - marking, 40
 - protecting, 23
 - review icons, 26
 - reviewing, 22
 - taking, modes, 14
 - transfer to computer, 38
- pictures/video
 - deleting, 23

- playing a video, 22
- power
 - camera, 6
- printing
 - from a card, 40
 - optimizing printer, 45
 - order online, 40
 - PICTBRIDGE, 39
 - tagged pictures, 40
- protecting pictures, videos, 23

Q

- quickview, using, 11

R

- recycling, disposal, 52
- regulatory information, 56
- repair, 49
- reset camera, 37
- reviewing pictures/video
 - as you take them, 11
 - deleting, 23
 - LCD, 22
 - protecting, 23
 - slide show, 27
- running slide show, 27

S

- safety, 53
- scene modes (SCN), 15
- SD/SDHC Card
 - inserting, 4
 - printing from, 40
- search pictures, 25
- select multiple pictures/videos, 32

self-timer, 17
setting
 camera sounds, 36
 color mode, 35
 computer connection, 37
 date and time, 6
 ISO, 34
 language, 36
 LCD brightness, 36
 picture size, 34
 picture-taking mode, 14
 self-timer, 17
 sharpness, 35
 video out, 36
 white balance, 35
setting up the camera, 1
setup menu, 36
Share Button App, 7
sharpness, 35
shutter
 problems, 46
 self-timer delay, 17
slide show
 continuous loop, 27
 running, 27
smart display, 36
smart find, 25
software
 install, 7
 upgrading, 53
software downloader, 38
sounds, 36
specifications, camera, 50
strap, 1

T
taking pictures, videos, 10
television, slide show, 28
text, entering, 20
time, setting, 6
timer, shutter delay, 17
tips
 battery guidelines, 54
 care & maintenance, 52
transfer pictures, 38
 Eye-Fi card, 43
trash can, deleting, 11
trimming a video, 31
troubleshooting, 45
turning camera on and off, 6
typing, 20, 21

U
undelete, undo, 23
underwater, 18
upgrading software, firmware, 53
URLs, Kodak Web sites, 45
USB
 transfer pictures, 38

V
video
 action print, 31
 edit, 30
 emailing marked, 21
 out, 36
 playback, 22
 protecting, 23
 review icons, 26

- transfer to computer, 38
- viewing, 22
- video out, 36
- viewing
 - by multi-up, 24
 - picture, after taking, 11, 22

W

- warranty, 55
- water, 18
- white balance, 35
- wireless EYE-FI card, 41

Z

- zoom, 13